

drawn left (right mirrorimage)

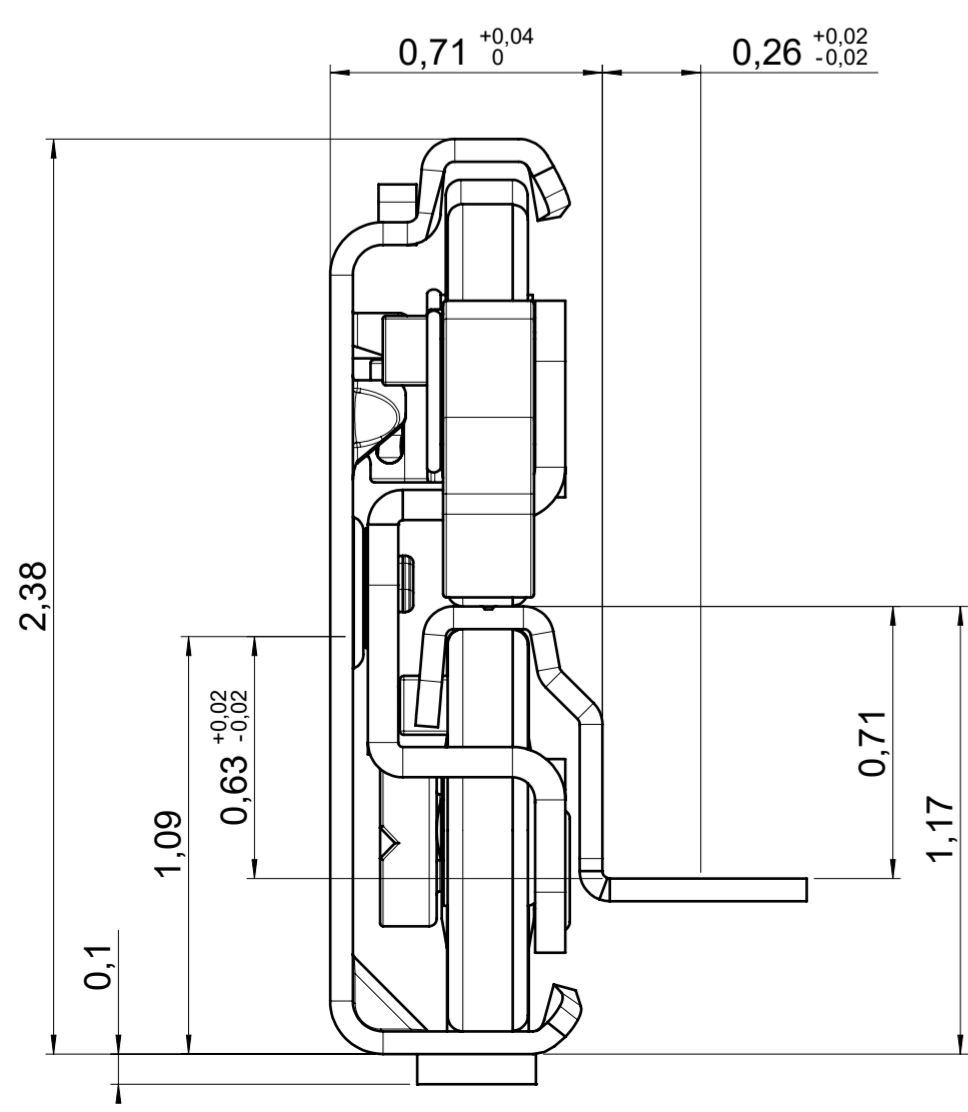
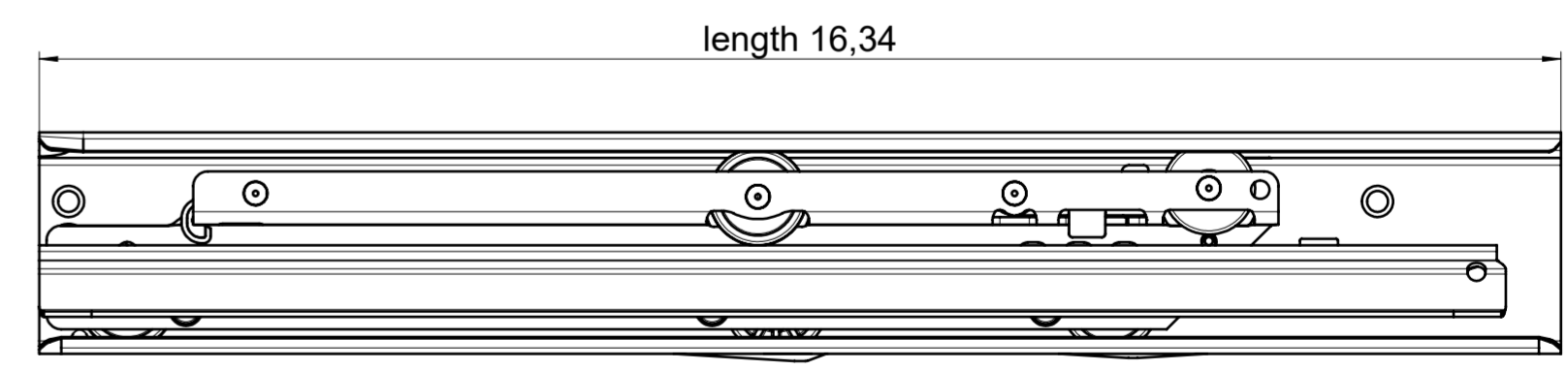
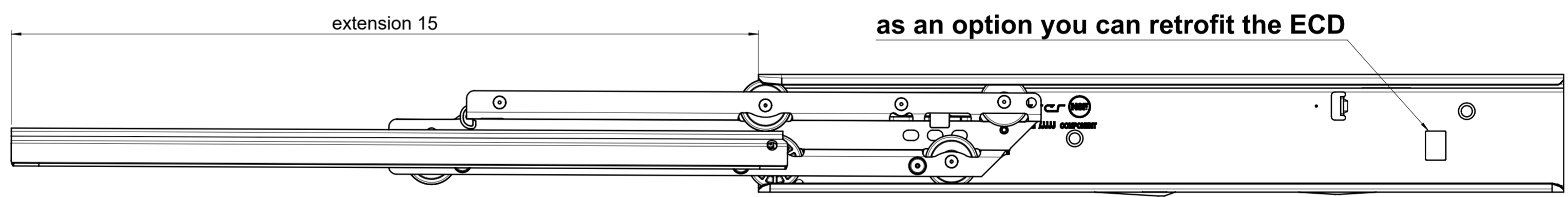
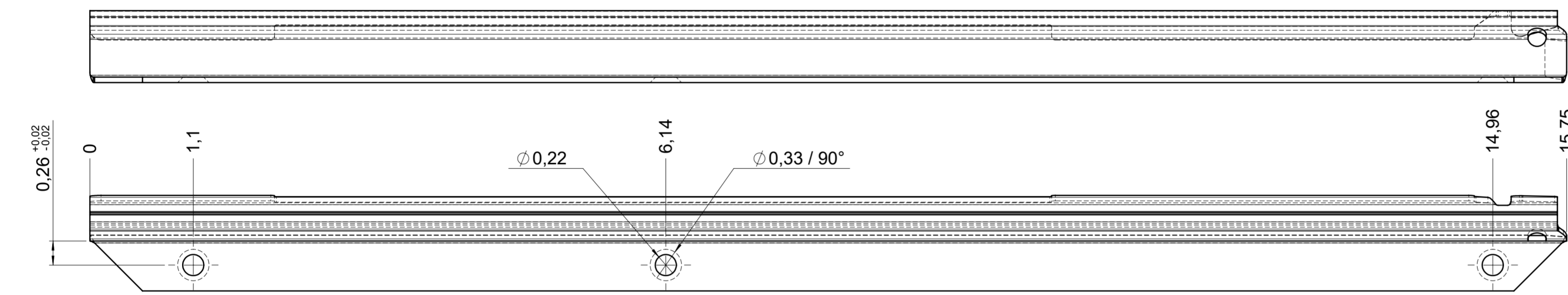
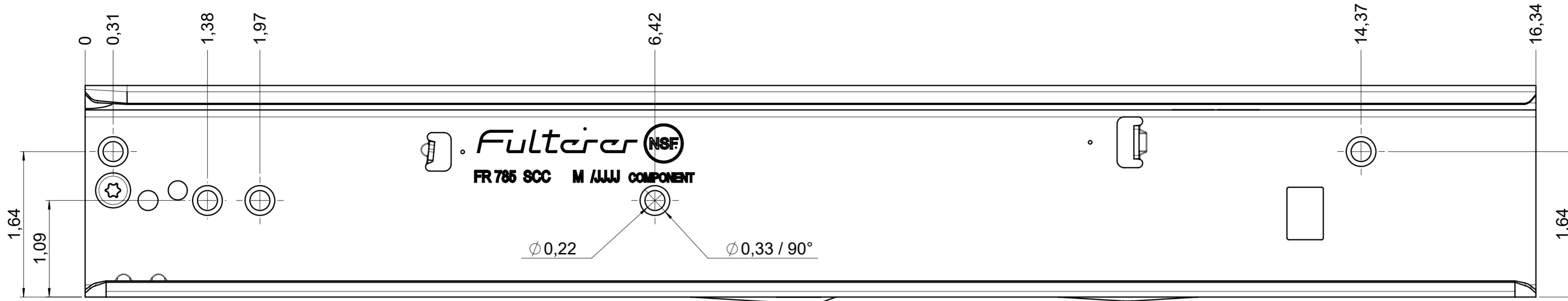

final approval

customer name:

signed by:

date:

all dimensions in inch				DIN ISO 128-30 missing dimensions see 3D = theor. intersection	
This drawing remains our property and may not be multiplied neither be disclosed to third parties (§§1,3 and 5 from the copyright Act (UrhG)) covered according to DIN ISO 16016					
scale: 1:1		surface:		material, semi finished parts: CS (technical requirements Fulterer)	
drawn 17-01-2023		date		description: FR 786 / 40 CS EN (inch) progressive-action full-extension drawerslide / bottom mount	
proven 01-02-2023		name		drawing number: CS# 786.400-GA.L501	
		pr		replaces version date:	
		Fulterer			
		Fulterer AG & Co KG A-6890 Lustenau / Austria			
		Fulterer AG CH-9430 St. Margrethen			
ind.	changes	date	na.		