

CABINET MOUNTING HOLES

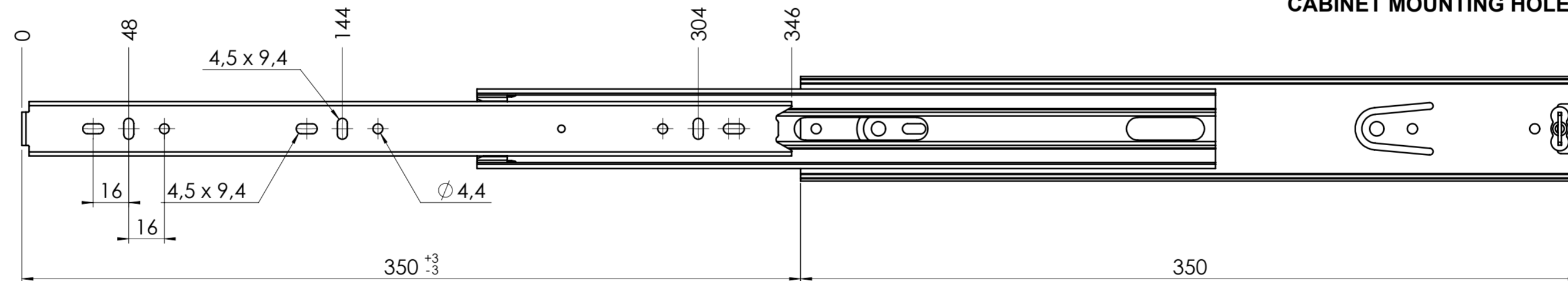

△xx = check dimension, next free check number /1

RECOMMENDED HARDWARE:
 CABINET- 3.5mm SPAX M4 BUTTON HEAD OR #8 TRUSS HEAD SCREW
 DRAWER- 3.5mm SPAX M4 BUTTON HEAD OR #8 TRUSS HEAD SCREW

general tolerances		DIN ISO 128-30	
stamping part according Fulterer W18-001	plastic part according DIN ISO 16742 TG4	missing dimensions see 3D	
This drawing remains our property and may not be multiplied neither be disclosed to third parties (§§1,3 and 5 from the copyright Act (UrhG))		= theor. intersection	
covered according to DIN ISO 16016		scale: 1:2	surface: A2
(k)		date	name
(l)		drawn 05-05-2022	CS
(m)		proven 00-00-0000	00
(n)		Fulterer	
(o)			
(p)		Fulterer AG & Co KG	
(q)		A-6890 Lustenau / Austria	
(r)		Fulterer AG	
(s)		CH-9430 St. Margrethen	
(t)		drawing number: 5047.350-GA.T000	
(u)		replaces version date:	
(v)			
(w)			
(x)			
(y)			
(z)			
ind.	changes	date	na.