

5210.450-GA.T107

X

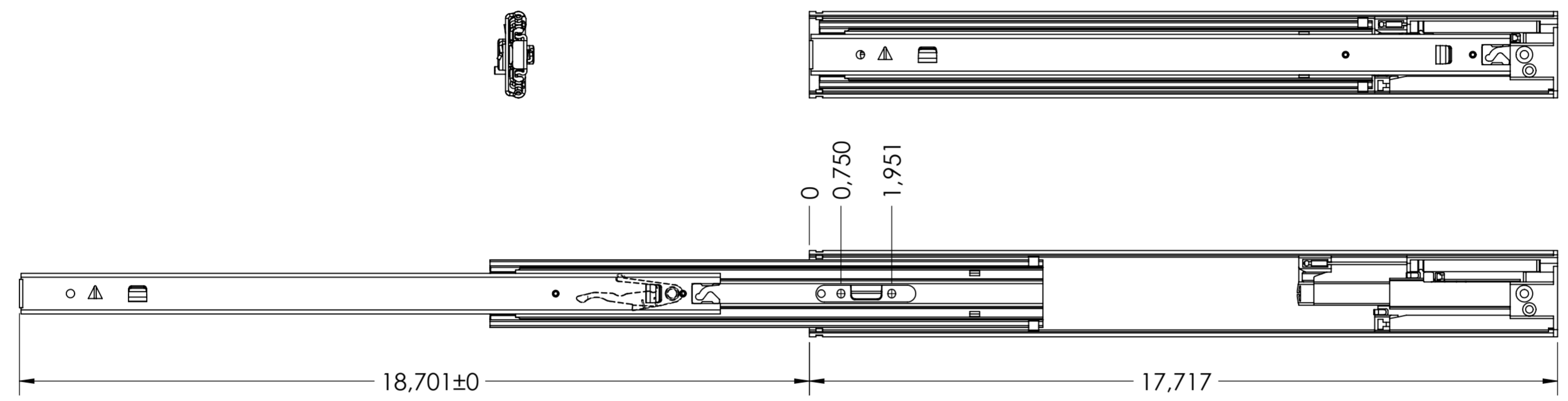

DRAWER MOUNTING CUTOUTS

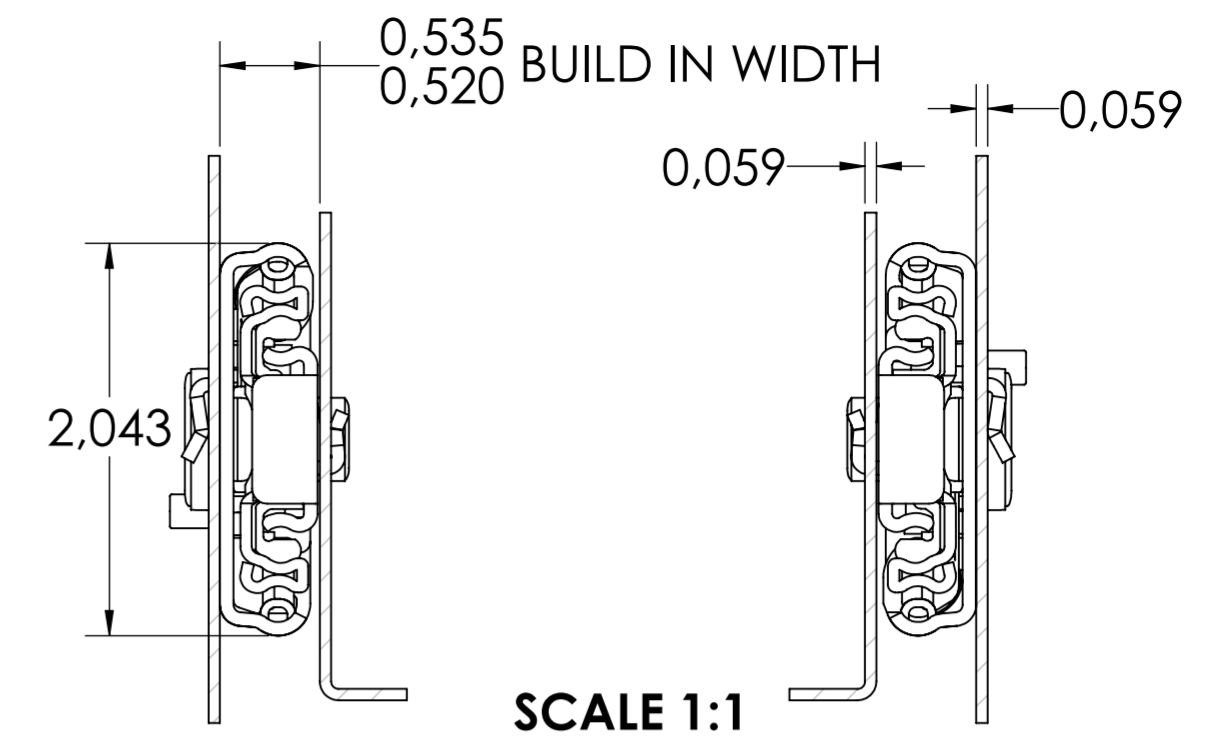
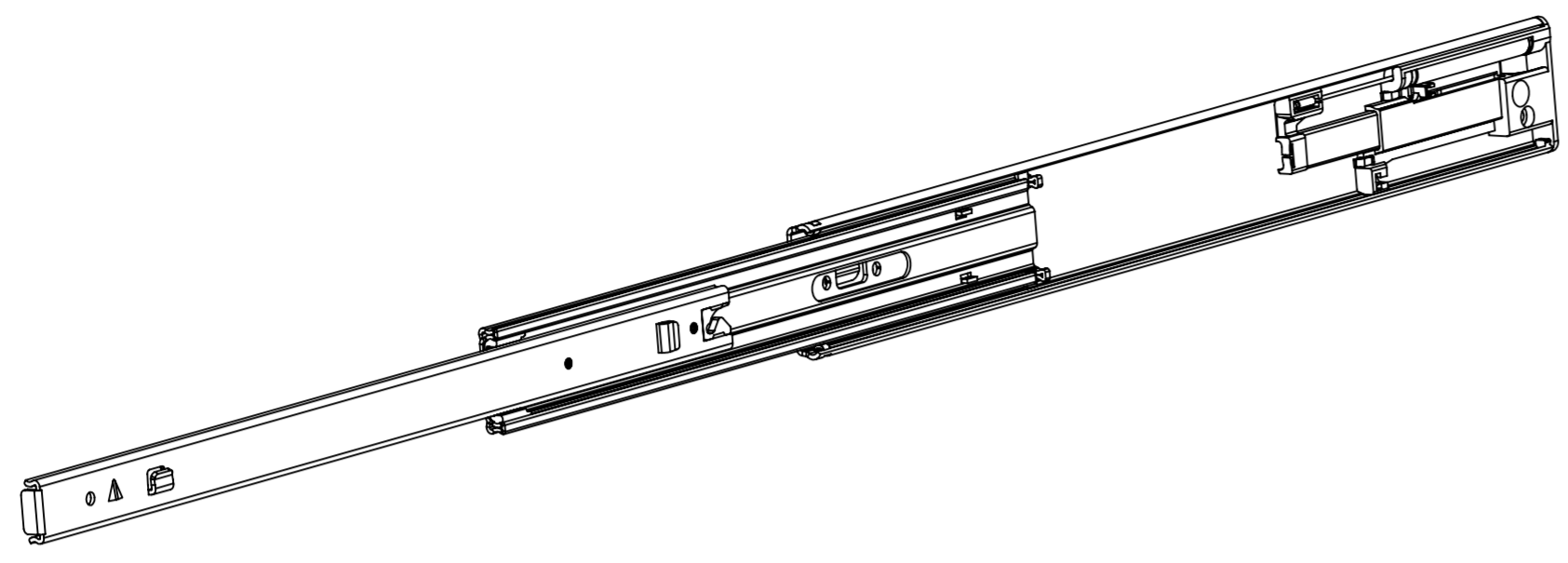
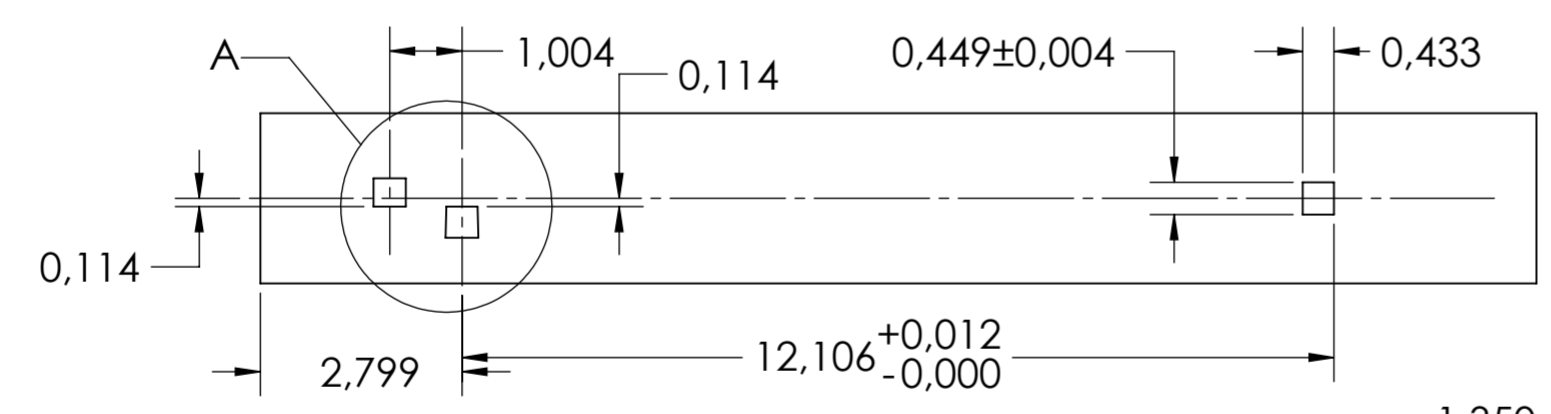

CABINET MOUNTING CUTOUTS

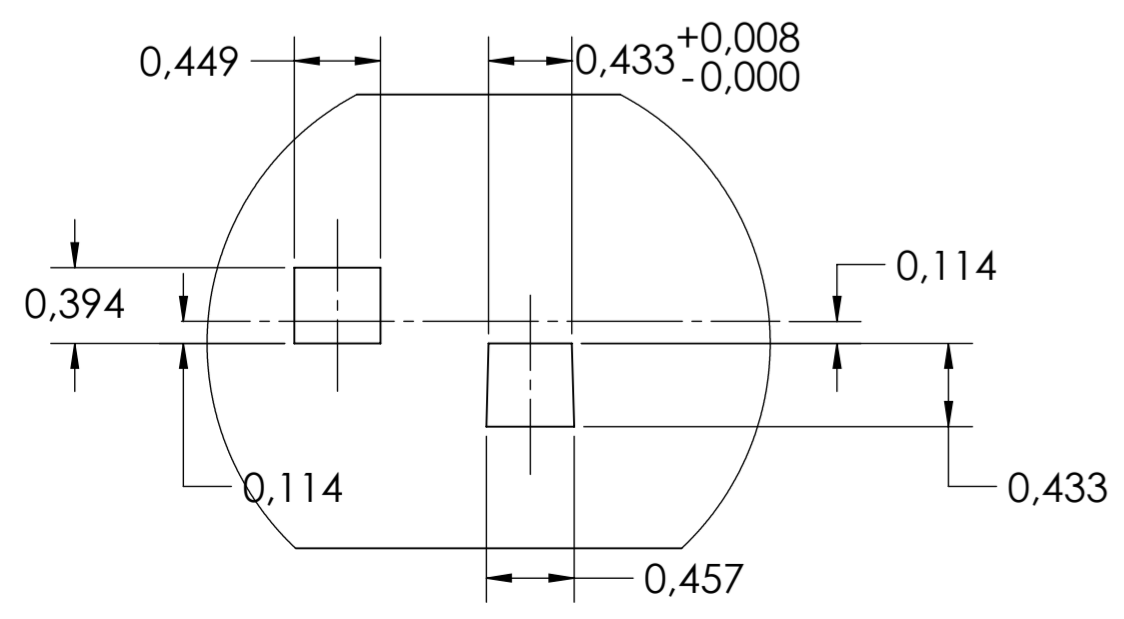
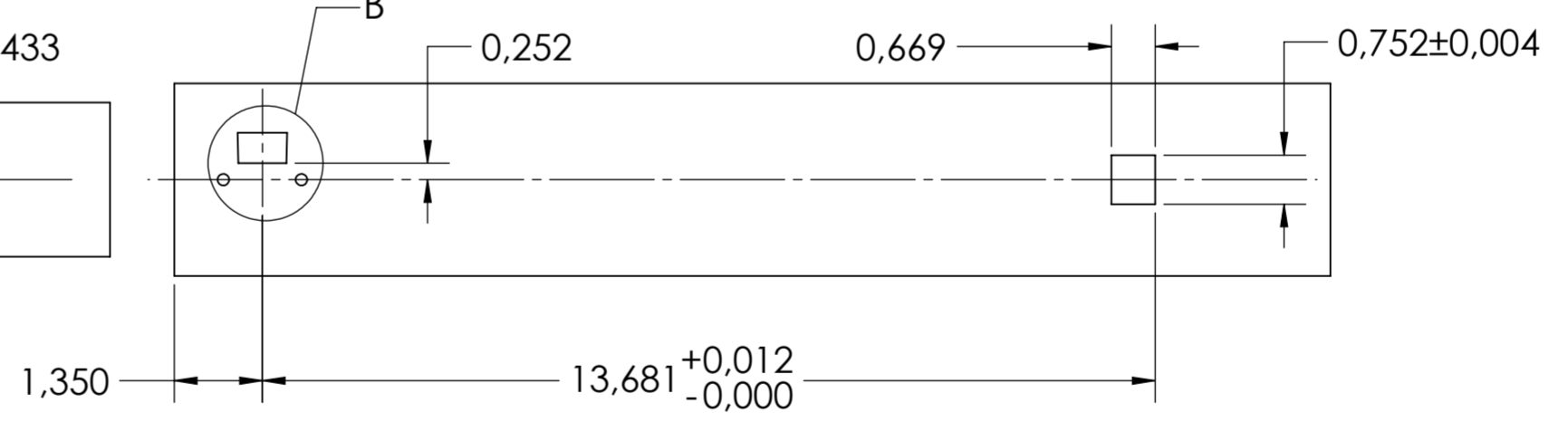

DETAIL A
SCALE 1:1

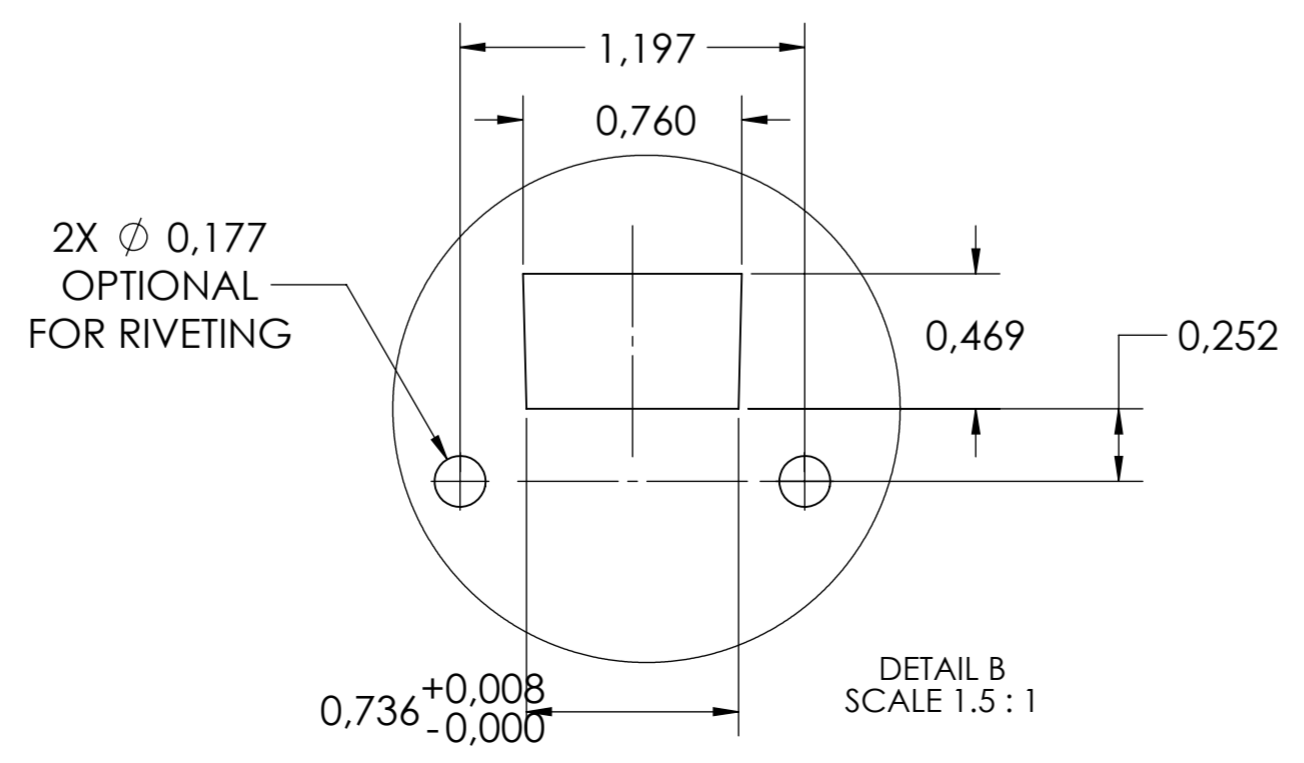

DETAIL B
SCALE 1.5:1

PULL OUT FORCE: 24N ± 2N (5.4 lbf. ± 0.5 lbf.)

general tolerances		DIN ISO 128-30 missing dimensions see 3D = theor. intersection	
ISO 2768-m			
This drawing remains our property and may not be multiplied neither be disclosed to third parties (§§1,3 and 5 from the copyright Act (UrhG)) covered according to DIN ISO 16016			
(k)	scale:	3:8	surface:
(l)	date	29-05-2019	name
(m)	drawn	HB	
(n)	proven	00-00-0000	00
(o)	Fulterer		material, semi finished parts:
(p)			STEEL
(q)	Fulterer AG & Co KG A-6890 Lustenau / Austria		description:
(r)			SIDE MOUNT OVER EXTENSION SMT (1.5) SLIDE WITH SOFT CLOSE & DRAWER DISCONNECT
(s)	Fulterer AG CH-9430 St. Margrethen		drawing number:
(t)			5210.450-GA.T107
(u)	changes	date	replaces version date:
(v)			