

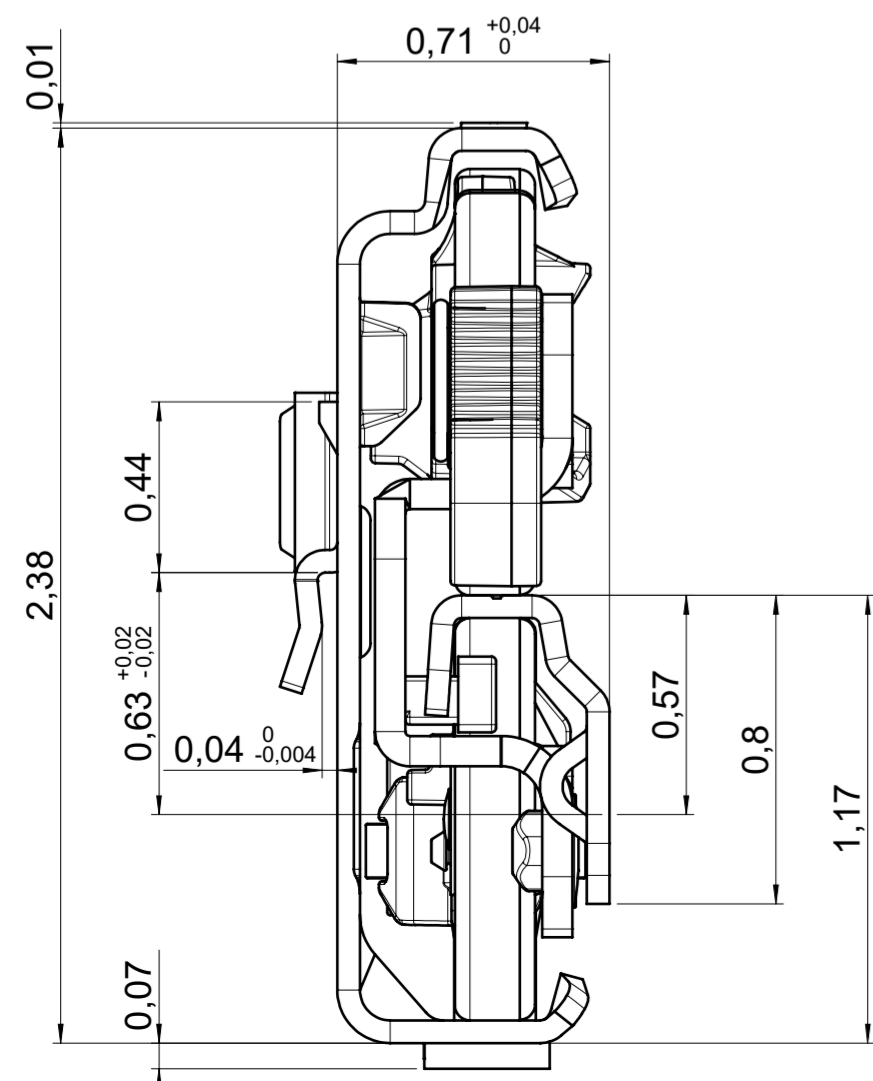

drawn on the left (mirrored on the right)

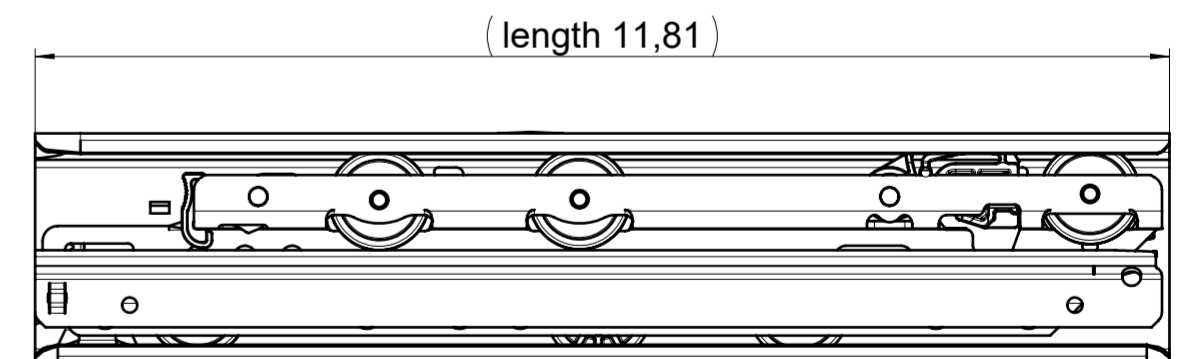
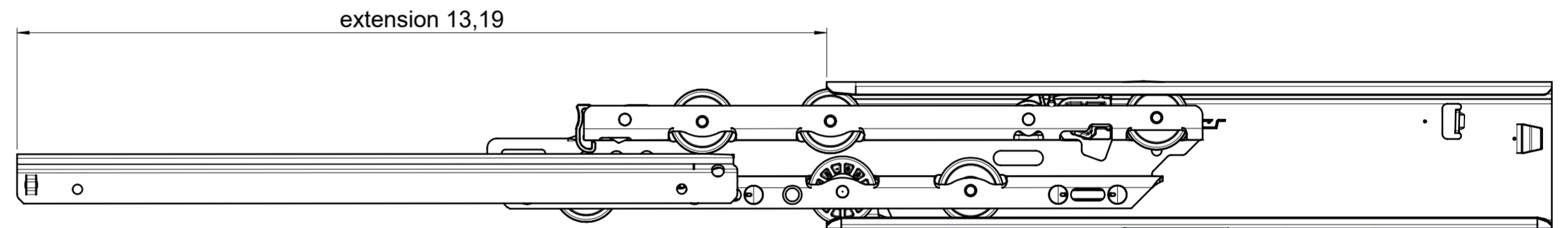
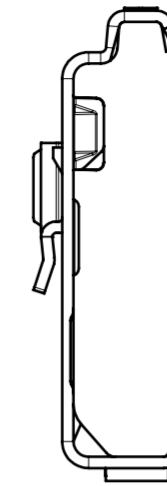
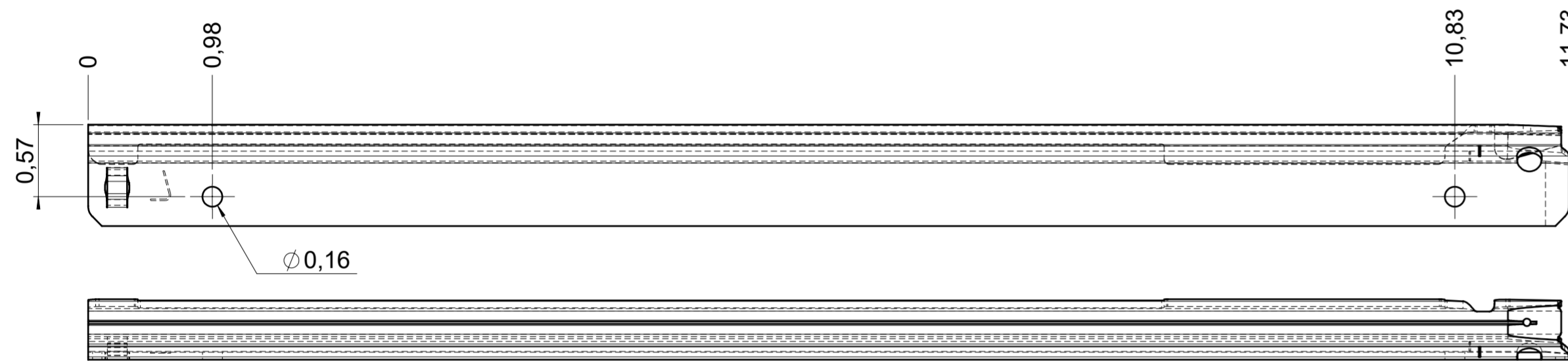
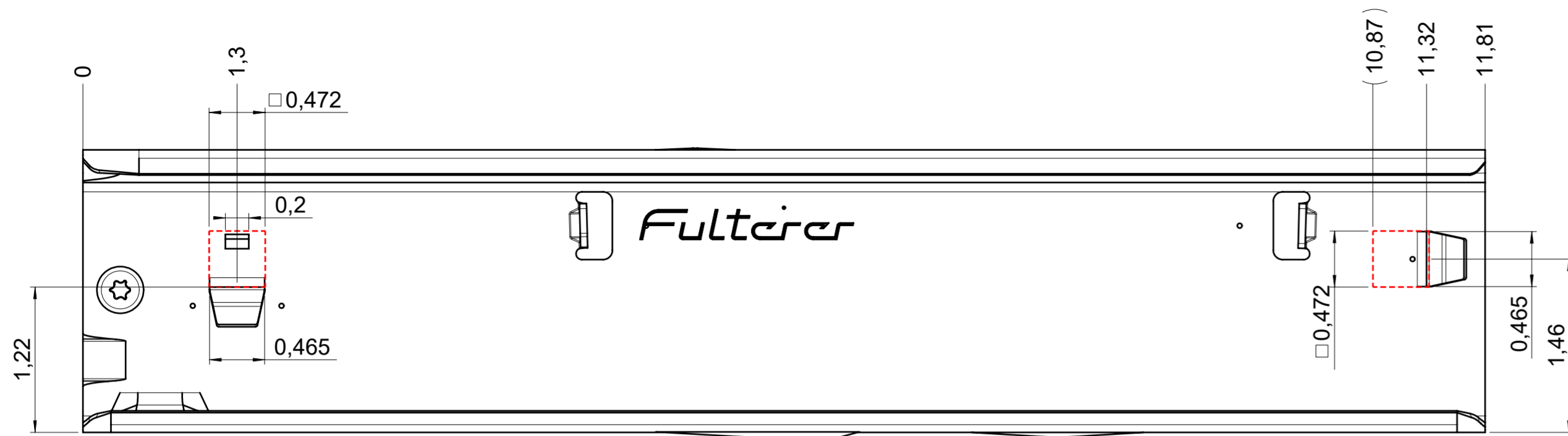

final approval	customer name:
	signed by:
	date:

all dimensions in inch			
missing dimensions see 3D = theor. intersection	scale: 1:1	surface/color:	material: CS (technical requirements Fulterer)
prototype approval	drawn	date	description: FR 795-300 CS EN (inch) progressive-action over-extension drawerslide / side mount
	proven	date	
 Fulterer AG & Co KG A-6890 Lustenau		drawing number: CS# 795.300-GA.L525	
		Fulterer AG CH-9430 St. Margrethen replaces the edition:	
This drawing remains our property and may not be multiplied neither be disclosed to third parties (§§1.3 and 5 from the copyright Act (UrhG)).			covered according to DIN ISO 16016